



# **INEN-6102 Multiplexer**

## **User Manual**

V2.0

**INITEL TELECOMMUNICATIONS**

# Chapter 1 Product Outline

## 1.1 Outline

.INEN-6102 multiplexer is a digital broadcasting TV system TS stream re-multiplexer. INEN-6102 multiplexer combines several single-programs or multiple-programs, which are compressed, coded, and multiplexed according to customer request by head-end, into single transport stream. Besides, it is also able to interpolate EPG (Electronic Program Guide), CA (Conditional Access) and digital broadcasting etc. Maximally, it can synchronal multiplex 8 route input code streams, and support ASI interface. The code rate of input code stream is maximally up to 270Mbps, while code rate of four separate outputs code stream is maximally up to 155Mbps. Through auxiliary data input channel, Its dimension is standard 1U case. By watching the LCD display on the front panel, user can finish the setting of auto-running of this device.

## 1.2 Features

- ◆Complying ISO13818 standard.
- ◆Multiplexing SPTS and MPTS code stream.
- ◆Support 8 single signal input
- ◆2 separate output
- ◆support scrambled signal transmit free
- ◆Draw out PSI/SI from any channel
- ◆Can point 256 PID in each channel
- ◆Input at most 30 program each channel, and 29 output
- ◆redefine PAT,PMT and other SI/PSI
- ◆Support PCR adjusting and PID re-reflection

- ◆ Have the function of insert and reflection of SDT/NIT
- ◆ Able to connect independent scrambler for scrambling to specified program or service.
- ◆ Generating SPI/SI information
- ◆ Support PCR adjusting and PID re-reflection
- ◆ out put data rate 0-155Mbps,188 byte format
- ◆ Each input support 270Mbps data rate, total 8 input rate is 576Mbps
- ◆ High precision PCR revise, usually holding 20-60ns
- ◆ MPEG2 program delay less than 100μs
- ◆ PID filtration/PID redefine function. User can delete, add, revise program even the program name, PID or serials No. easily.
- ◆ Chinese and English LCD display
- ◆ Ethernet interface10/100M, long-distance control multiplexer via PC
- ◆ Have the function of parameter memory
- ◆ Have the function of PSI auto-built.
- ◆ High reliability design, stable in running
- ◆ Alarm display
- ◆ Support network upgrade

### 1.3 Performance Index

Input Interface	ASI	8Routes Standard ASI Interfaces
		Maximum 270Mbps per route
Re-multiplexing		Re-multiplexing MPEG-2 stream
		PID re-reflection
		PCR reset
		Automatically generating PSI/SI table
Output Interface	ASI	4 routes(2 groups separate output)

PID	Output PID range	0000-1FFF
	Random PID transparent transport	Random PID transparent transport possible
	Max PID number for each input	256
Data input	Format	Auto identification, 188/204byte, encoding
	Ethernet port	10/100M
Miscellaneous	Dimension	44mmx482mmx410mm
	Temperature	0-45°C (Operating) ; -20-80°C (Storage)
	Power	110/220VAC ± 10%, 50Hz, 2.5W

### 1.4 Principle Chart

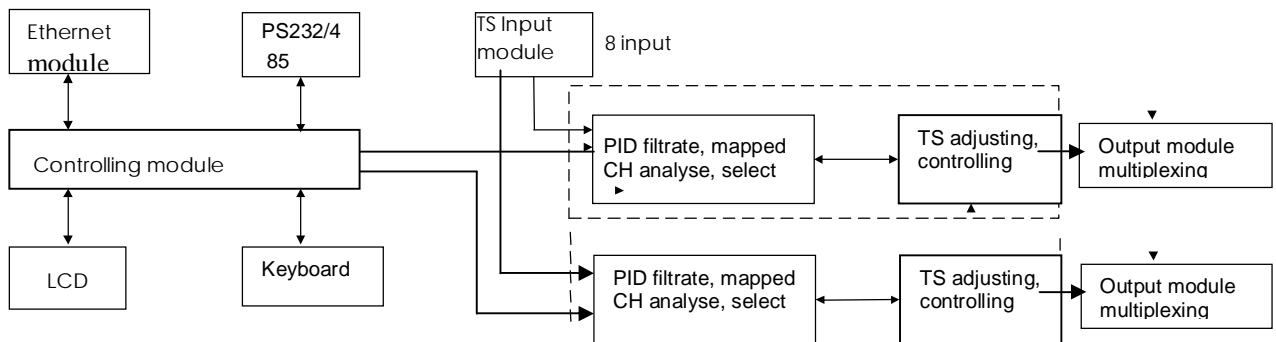

### 1.5 Appearance and Description

Front Panel Illustration:

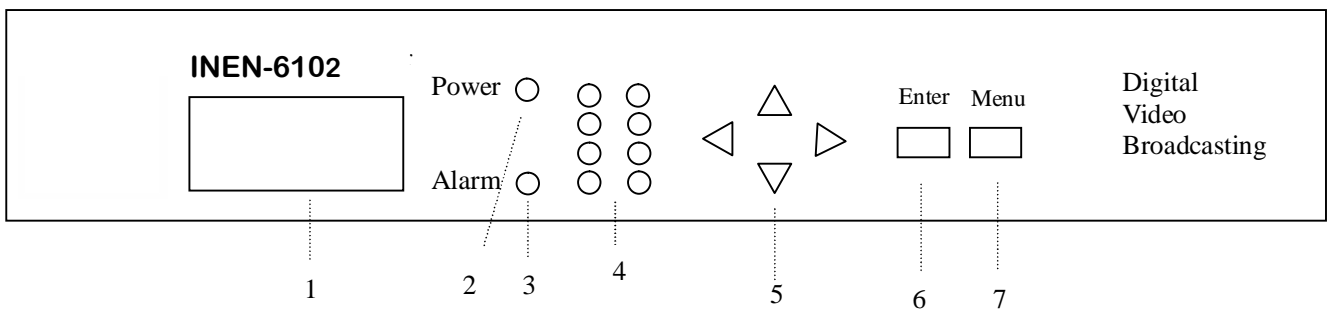

1	LCD Display Interface
2	Power Indicator
3	Alarm Indicator
4	Input CH lock indicator
5	Up /Down/Left/Right Arrow
6	Enter key
7	Menu Key

Rear Panel Illustration

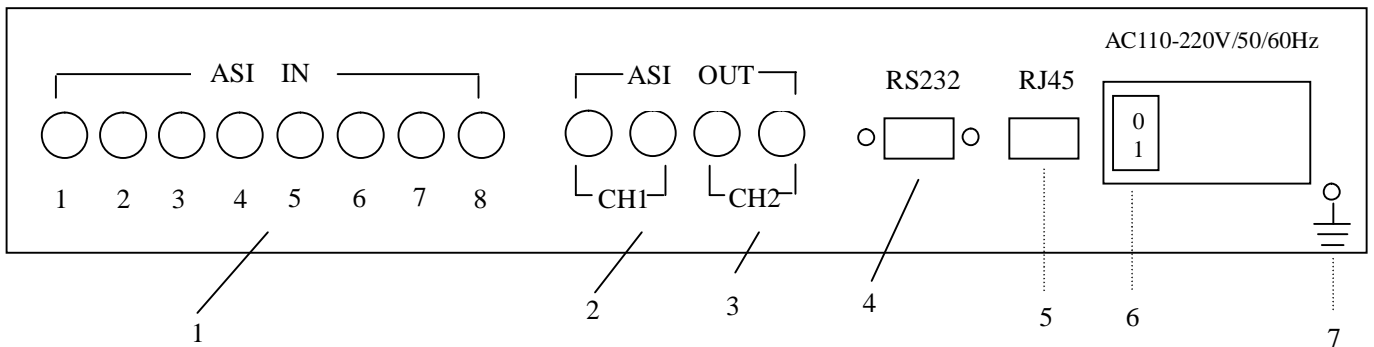

1	8 ASI Input CH
2	Output CH1
3	Output CH2
4	RS232
5	RJ45
6	AC Power Socket
7	Grounding

# Chapter 2 Installation Guide

## 2.1 Acquisition Check

When users open the package of the device, it is necessary to check items according to packing list. Normally it should include the following items:

- **INEN-6102** ? multiplexer 1
- User's Manual 1
- ASI digital signal input and output wire 8
- AC Input Power Cord 1

If any item is missing or mismatch with the list above, please contact local dealer.

## 2.2 Installation Preparation

When users install device, please follow the below steps. The details of installation will be described at the rest part of this chapter. Users can also refer rear panel chart during the installation.

The main content of this chapter including:

- Checking the possible device missing or damage during the transportation
- Preparing relevant environment for installation
- Installing Encoder **INEN-6102** Multiplexer
- Connecting signal wires

### 2.2.1 Device's Installation Flow Chart Illustrated as following:

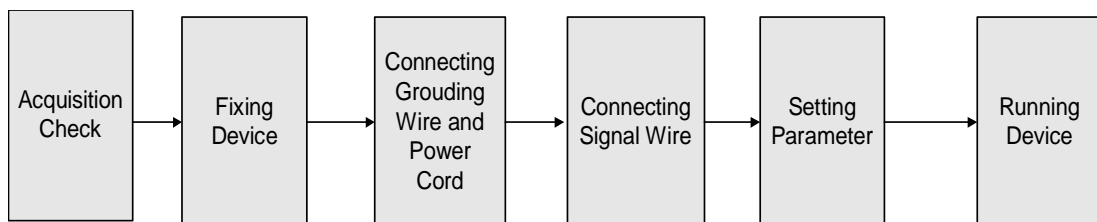

## 2.2.2 Environment Requirement

Item	Requirement
Machine hall space	When user install machine frame array in one machine hall, the distance between 2 row of machine frames should be 1.2~1.5m and the distance to wall should be no less than 0.8m.
Machine hall floor	Electric Isolation, Dust Free Volume resistivity of ground anti-static material:1(107~1(1010(, Grounding current limiting resistance: 1M(。 Floor bearing should be greater than 450Kg/m2。
Environment temperature	5~40(C sustainable , 0~45(C short time, installing air-conditioning is recommended
Relative temperature	20%~80% sustainable 10%~90% short time
Pressure	86~105KPa。
Door & window	Installing rubber strip for sealing door-gaps and dual level glasses for window
Wall	It can be covered with wallpaper, or brightness less paint.
Fire protection	Fire alarm system and extinguisher
Power	Requiring device power, air-conditioning power and lighting power are independent to each other. Device power requires AC power 220V 50Hz,50W Please carefully check before running.

## 2.2.3 Grounding Requirement

- All function modules' good grounding designs are the base of reliability and stability of device. Also, they are the most important guarantee of lightning arresting and interference rejection. Therefore, system must follow this rule.
- Coaxial cable's outer conductor and isolation layer should keep sound electric

conducting with the metal housing of device.

- Grounding conductor must adopt copper conductor in order to reduce high frequency impedance, and the grounding wire must be as thick and short as possible.
- The 2 terminals of grounding wire must make sure for well electric conducting, and process for antirust.
- It is prohibited that users use other devices as part of grounding wire's electric circuit
- The section of the conjunction between grounding wire and device's frame should be equal or greater than 25mm<sup>2</sup>

#### 2.2.4 Frame Grounding

All the machine frames should connect to protective copper strip. The grounding wire should be as short as possible and avoid circling. The section of the conjunction between grounding wire and grounding strip should be equal or greater than 25mm<sup>2</sup>.

#### 2.2.5 Device Grounding

Connecting the device's grounding rod to frame's grounding strip with copper wire.

### 2.3 Wire's Connection

The power supply outlet is located at the left of rear panel, and the power switch is just above it. The protective grounding wire connective screw is located at the down-left side of power supply outlet

- Connecting Power Cord

User can insert one end into power supply outlet, while insert the other end to AC power.

- Connecting Grounding Wire

When the device solely connects to protective ground, it should adopt independent way, say, share the same ground with other devices.



When the device adopts united way, the grounding resistance should be smaller than  $1\Omega$

---

**⚠ Caution:**

**Before connecting power cord to Encoder, user should set the power switch to “OFF”.**

---

## 2.4 Signal Wire Connection

The signal connections include the connection of input signal wire and the connection of output signal wire. The signal connection wire are both ASI.

### 2.4.1 ASI Input Connection

User can find ASI IN1-IN8 input port on the Equipment, according to connector mark described in the rear panel illustration, and then, connecting the Q9 coaxial cable, one end to the ASI IN1-8 and the other end to the Encoder's or other equipment ASI output port.

### 2.4.2 ASI Output Port Connection

User can find ASI output port on the Equipment, according to connector mark described in the rear panel illustration, and then, connecting the ASI cable (in the accessories), one end to the **INEN-6102** multiplexer's ASI output port and the other end to the scrambler's or Modulator's input port. multiplexer's ASI output port and its connected ASI cable connector illustrated as follow:



# Chapter 3 Operation

This **INEN-6102** multiplexer's front panel is user operation interface. Before operating, we should collocate input and output parameter. Input setting includes the select of multiplexed channels, output parameter includes setting of TS output. Equipment supply perfect Chinese and English menu for user select, detail operations go as follows:

## Front Panel Keyboard Function Description

ENTER: Activating and edit the parameters which needs modify, or confirming the change after modification and turn over;

UP、DOWN、LEFT、RIGHT: Turn over/Edit parameter

MENU: Lock/Cancel/Save/Show current station

### 3.1 Main page: Common station

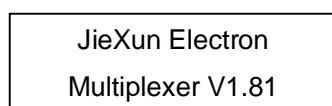

JieXun Electron  
Multiplexer V1.81

### 3.2 Press ENTER to main menu

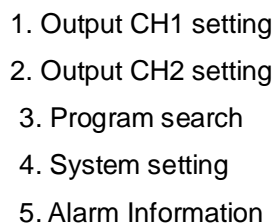
- 
1. Output CH1 setting
  2. Output CH2 setting
  3. Program search
  4. System setting
  5. Alarm Information

Press UP/DOWN to select

### 3.3 Output CH1 setting

When user select this setting, the system will show as follows:

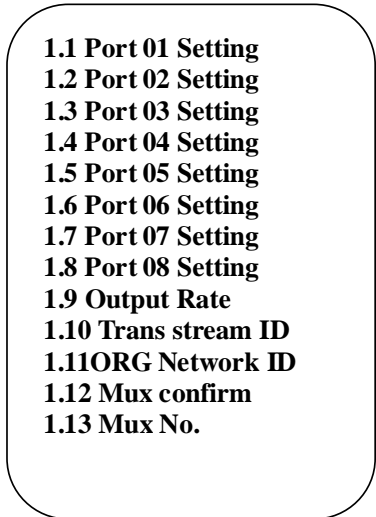

User can finish the select of program or parameter at each input port

### 3.4 Port 01 Setting

When user select this setting, the system will show as follows:

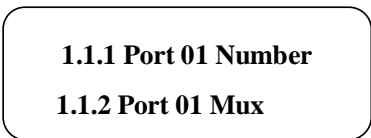

If want to edit the TS of other ports, select the related port will be ok

### 3.5 Output Rate

When user select this setting, the system will show as follows:

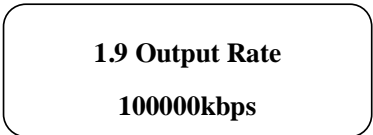

### 3.6 Trans Stream ID

When user select this setting, the system will show as follows:

1.10 Trans Stream\_ID  
0x0000

**3.7 ORG network ID**

When user select this setting, the system will show as follows:

1.11 Original\_network\_ID  
0x0000

**3.8 Mux Confirm**

When user select this setting, the system will show as follows:

1.12Yes ———▶Enter  
No ———▶Menu

**3.9 Mux Number**

When user select this setting, the system will show as follows:

1.13 Output 01 Mux Sum: XX

**3.10 Output CH2 Setting**

The same as the setting of CH1

**3.11 Program search**

When user select this setting, the system will show as follows:

3.1 Auto All Search  
3.2 Port Search

### 3.12 System setting

When user select this setting, the system will show as follows:

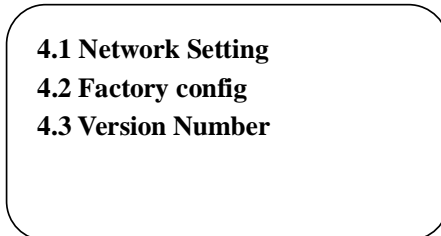

### 3.13 Network Setting

When user select this setting, the system will show as follows:

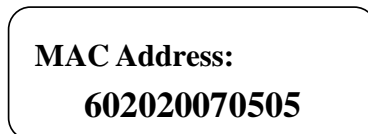
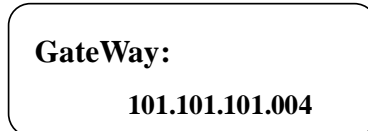
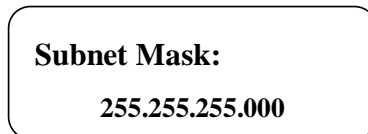
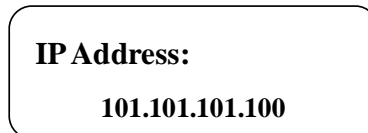

### 3.14 Factory config

When user select this setting, the system will show as follows:

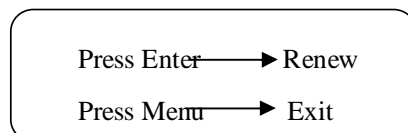

### 3.15 Version Number

When user select this setting, the system will show as follows:

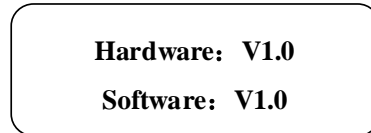

### 3.16 Language select

When user select this setting, the system will show as follows:



Press UP/DOWN to select language, the “\*” direct the selected one. Default is Chinese version.

### 3.17 Alarm Information

When user select this setting, the system will show as follows:



Finish all the setting, the multiplexer can operate normally.